

SKYROOF



BIOCLIMATIC
PERGOLAS

PALMIYE
Four Seasons Outdoor Living Areas

Spaces to live for



Your Outdoor Living Areas



Greet Deep Forces of Nature
with Peace of Mind



INDEX



PRESTIGE 10



PLUS & COMPACT 28

P P C

PRESTIGE PLUS COMPACT

SKYROOF SERIES

Get over the limits and meet the Skyroof family. You can choose Skyroof to suit your needs and desires with unlimited personalization.

SKYROOF PRESTIGE



SERIES

12

Prestige

FEATURES

14

Panel Movement

16

Integrated Panel Gutter

18

Climate Control

19

Venilation Mode

20

Multi - Sealing System

OPTIONS & DETAILS

42

Lighting Options

44

Control & Automation

46

Side Cover Options

48

Colour Options

50

Integrated Beam & Drainage System

52

Modularity

53

Application Types

SKYROOF PRESTIGE

With its innovative sense of comfort, it allows you to retract to fully feel the sky.



MAX DIMENSIONS

Projection* (freestanding)	691,3 cm
Width	400 cm
Snow Load (max)	268 kg/m ²
Max. Open Space	%79

*2,8 cm bracket width needs to be added for wall mounted installation.

OPTIONS

Lighting	Perimeter Lighting (only)
Panels	Insulated
Colour	Dual Colour

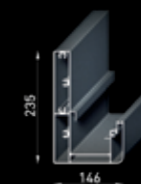

Integrated Beam

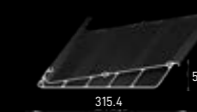

Panel

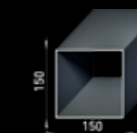

Pillar

Skyroof Prestige manufactured with four pillars up to a projection measure of 579,9 cm. Above this, one more pillar needs to be added for each of projection sides. The projection measure changes in multiples of 27,9 cm.

PANEL MOVEMENT

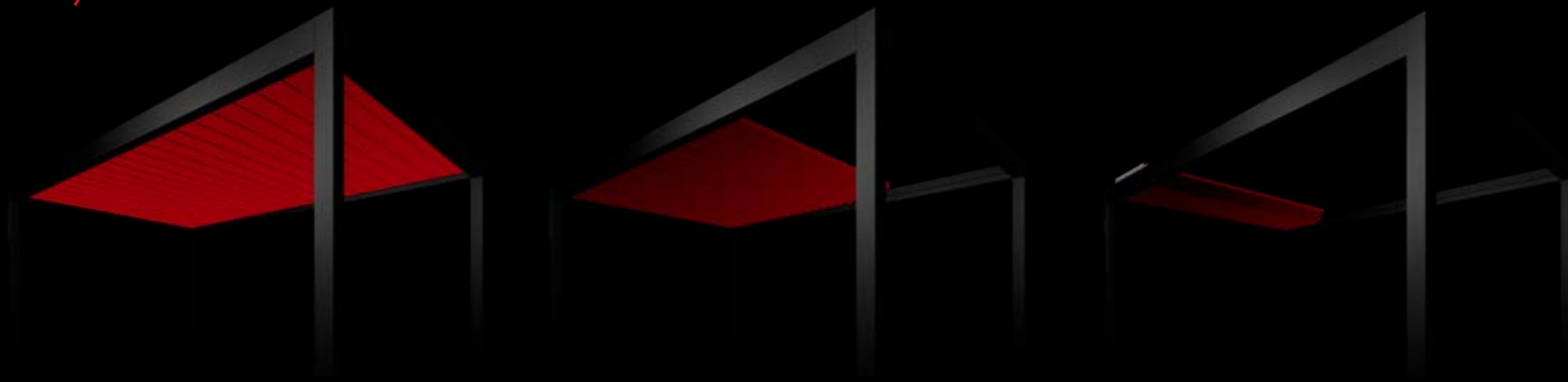

Retraction Movement

The retractable ceiling of Skyroof Prestige provides an open roof space of %79 of the total covered area, due to the synchronised movement of the creatively designed panels.

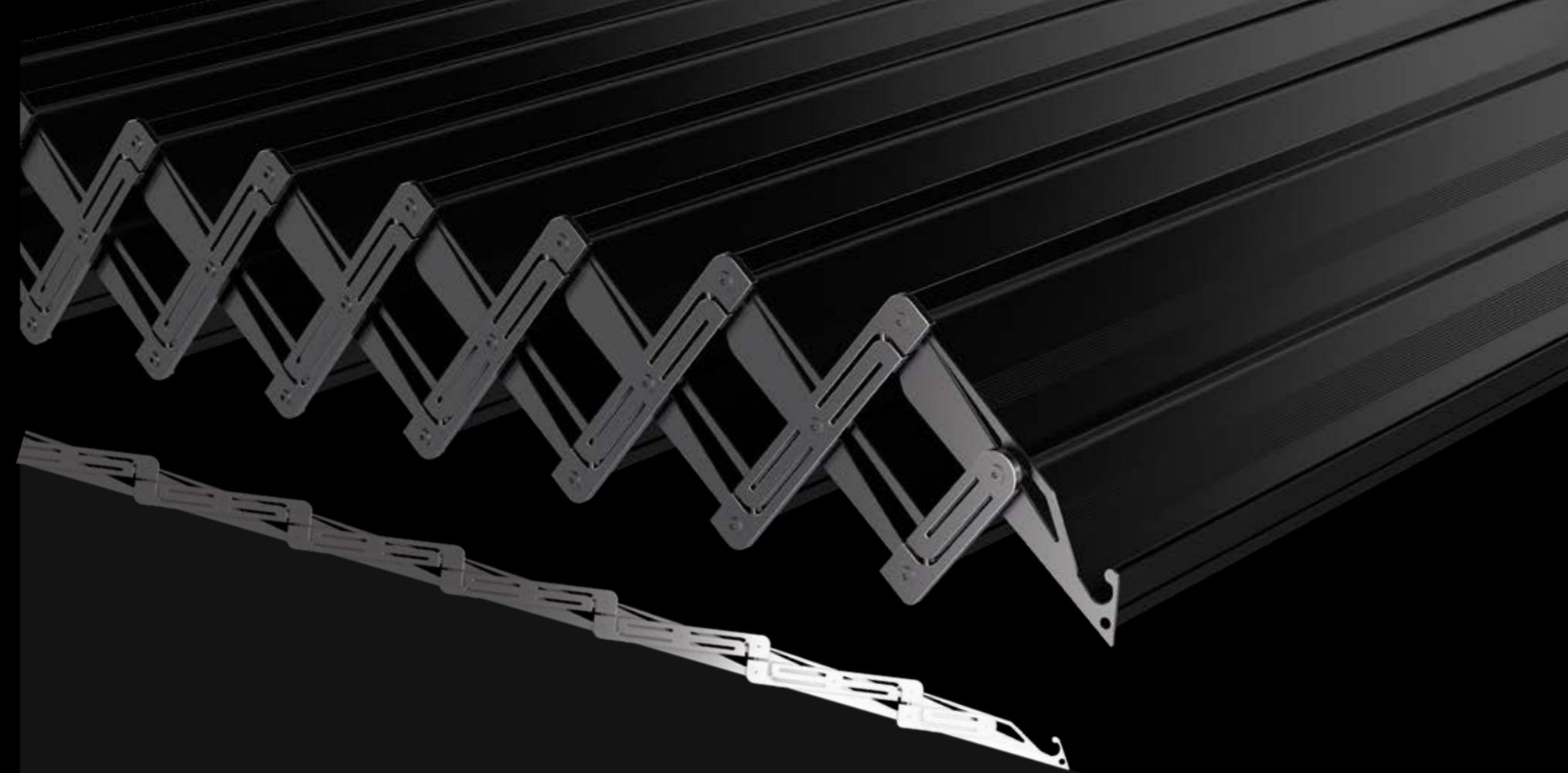

Synchronized Panel Movement

This special synchronized movement is the newest technological system, allowing simultaneous retraction of all panels.

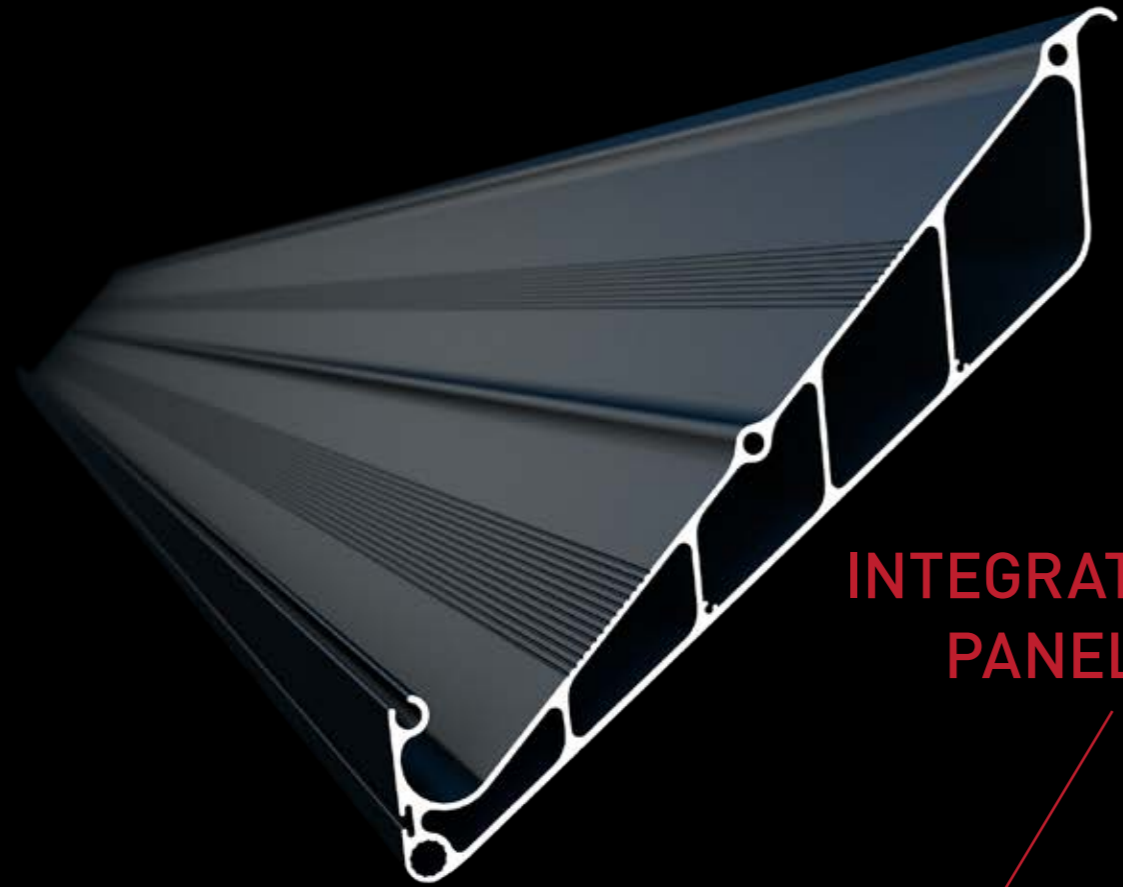

INTEGRATED PANEL GUTTER

Stay Clean

The elliptical chamber on the top side of the panel prevents the accumulated materials falling into your indoor space during the panel rotation.

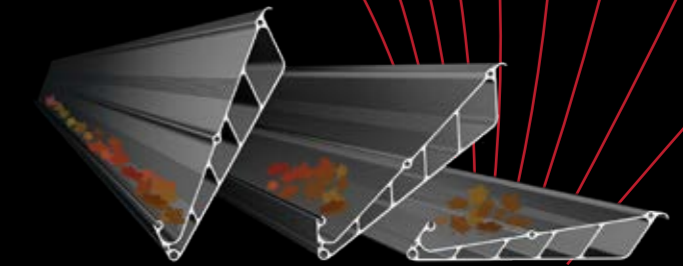

Internal Panel Inclination

A 8.75% internal inclination on the top of the panels ensures perfect drainage by preventing water accumulation on the system.

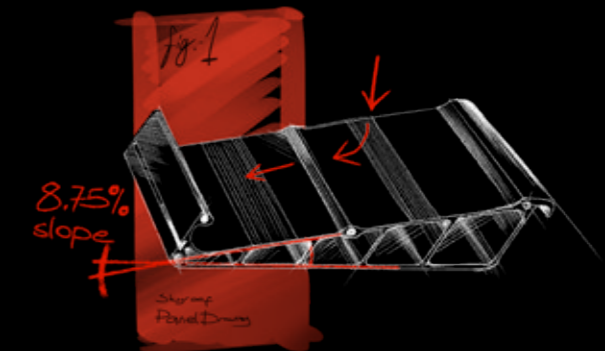

CLIMATE CONTROL

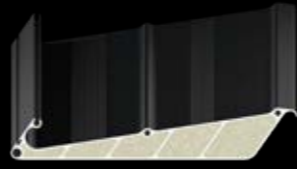
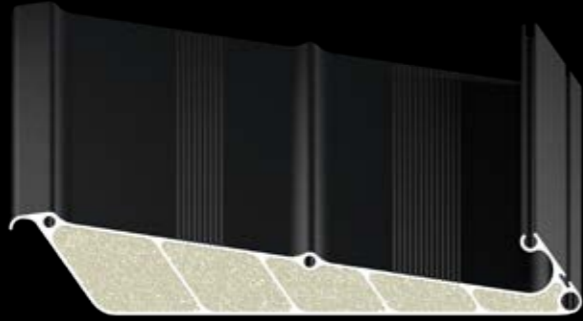

Insulated

Insulated Panels

Panels can be filled with Polyurethane Foam which provides extra comfort. It significantly helps to reduce condensation.



Standard

Air Tunnels

The panel structure provides certain level of insulation.

VENTILATION MODE

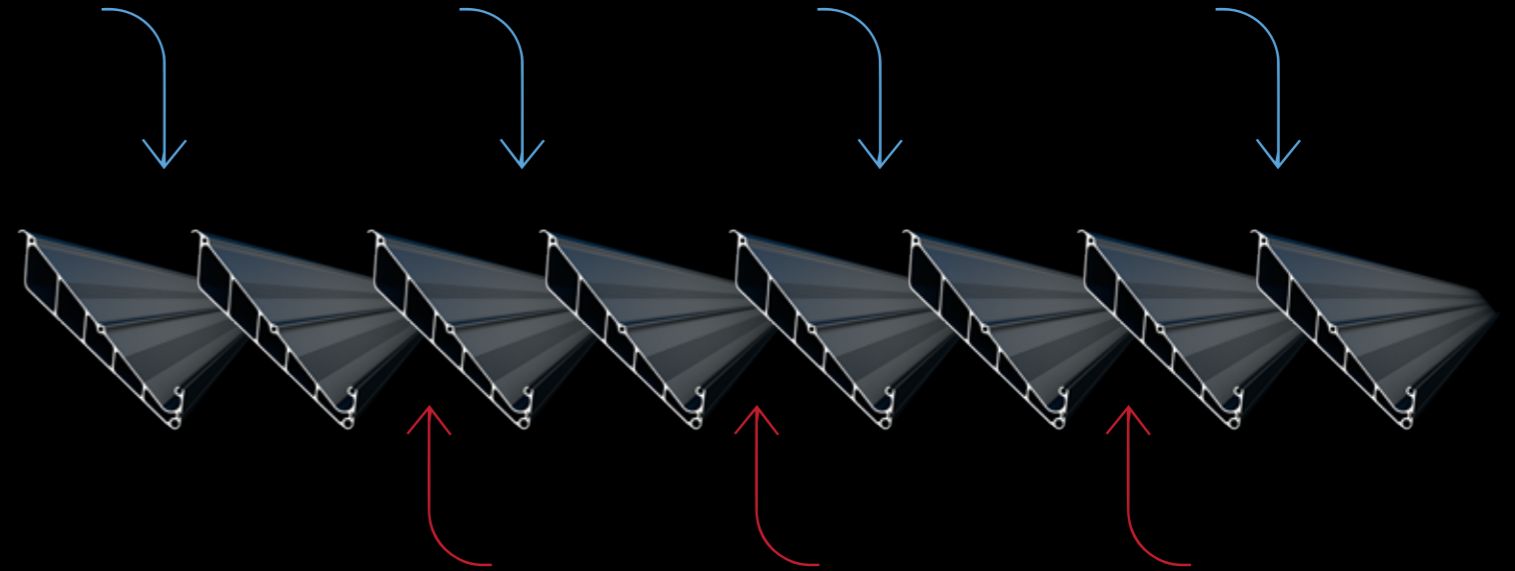

'MY' button on your remote control allows you to refresh the air with a single touch and provide fresh air in to the room ; while "Connexoon" feature supports creating your own ventilation scenario via your smartphones.

MULTI-SEALING SYSTEM

Synchronized moving panels simultaneously presses the gaskets located on the integrated beams and thus ensure maximum insulation during the closing movement.

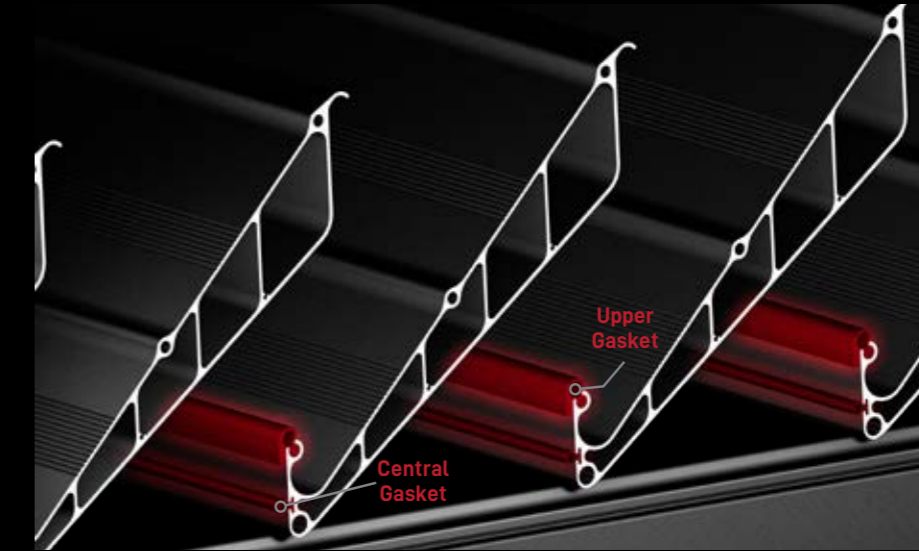
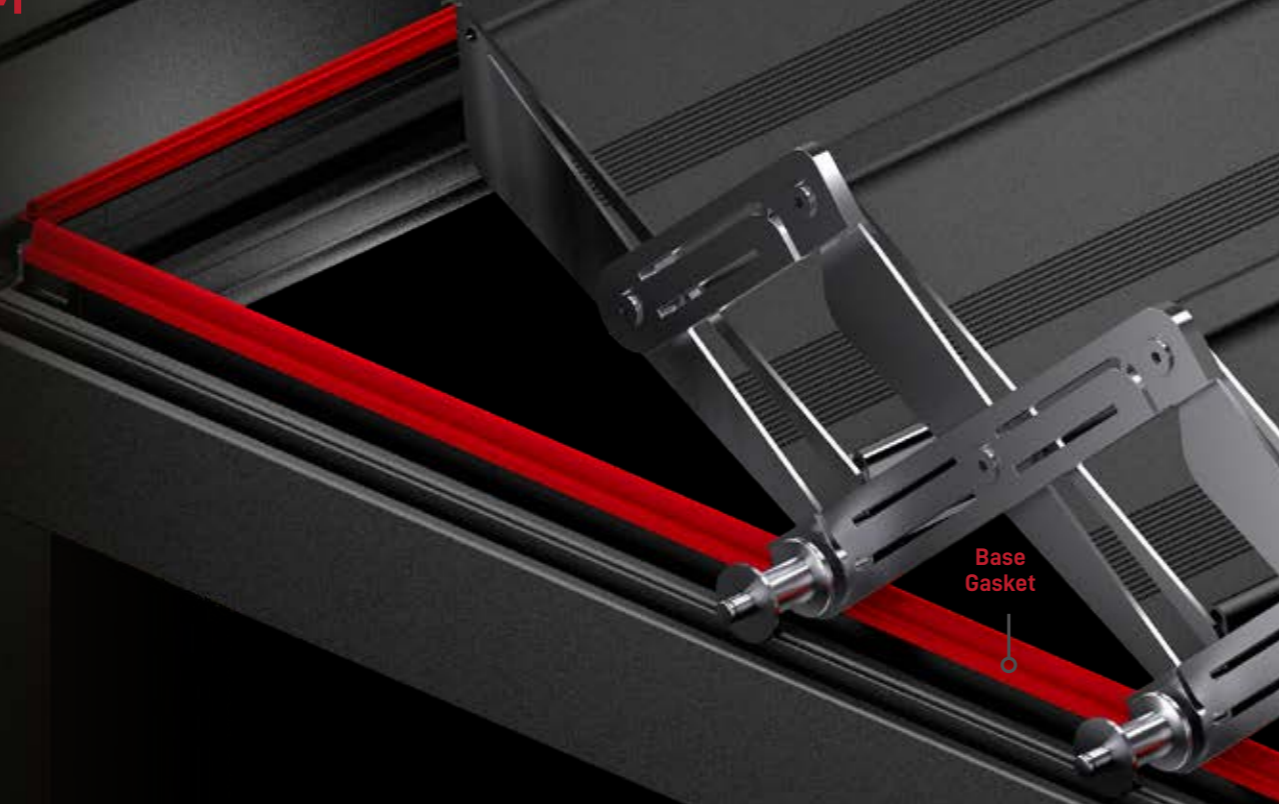

Panel Interlock

Thanks to the synchronous closing movement of the panels, the gaskets on the panels are clamped together at the same time and a complete insulation is provided between the panels.

SKYROOF PLUS & COMPACT



SERIES

24
Plus

26
Compact

FEATURES

28
Panel Rotation

30
Integrated Panel Gutter

32
Climate Control

34
Multi Sealing System

36
High Pressure Closing Function

OPTIONS & DETAILS

42
Lighting Options

44
Control & Automation

46
Side Cover Options

48
Colour Options

50
Integrated Beam & Drainage System

52
Modularity

53
Application Types

SKYROOF PLUS

The Plus series are perfect choice in all weather conditions. It's strong, it's powerful, it's multifunctional, it's modular to cover large areas.



MAX DIMENSIONS

Projection* (freestanding) 799 cm

Width 450 cm

Snow Load (max) 336 kg/m²

**2,8 cm bracket width needs to be added for wall mounted installation.*

OPTIONS

Lighting Linear Lighting
Perimeter Lighting

Panels Insulated

Colour Dual Colour

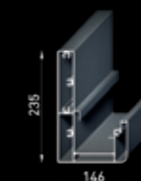

Integrated Beam



Panel

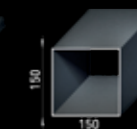

Pillar

The Plus series is manufactured with four pillars up to a projection measure of 587,5 cm. Above this, one more pillar needs to be added for each of projection sides. The projection measure changes in multiples of 17,6 cm for both series.

SKYROOF COMPACT

Created
for those
who desire
minimalism.



MAX DIMENSIONS

Projection* (freestanding)	512,3 cm
Width	350 cm
Snow Load (max)	203 kg/m ²

**2,8 cm bracket width needs to be added for wall mounted installation.*

OPTIONS

Lighting	Perimeter Lighting (only)
Colour	Dual Colour

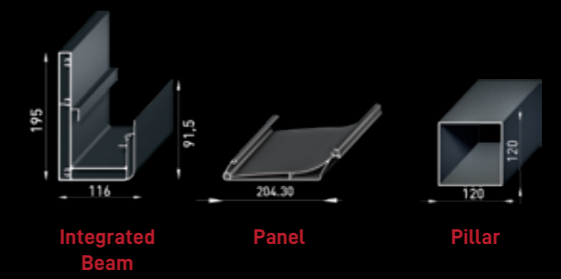

The projection measure changes in multiples of 17,6 cm.



INNOVATIVE PANEL ROTATION

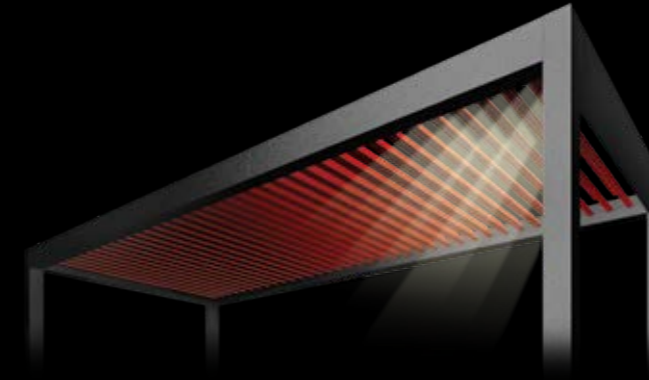

The motorized roof consists of rotatable aluminium panels. Palmiye's revolutionary design allows the panels at any angle up to 120 degrees seamlessly manner.

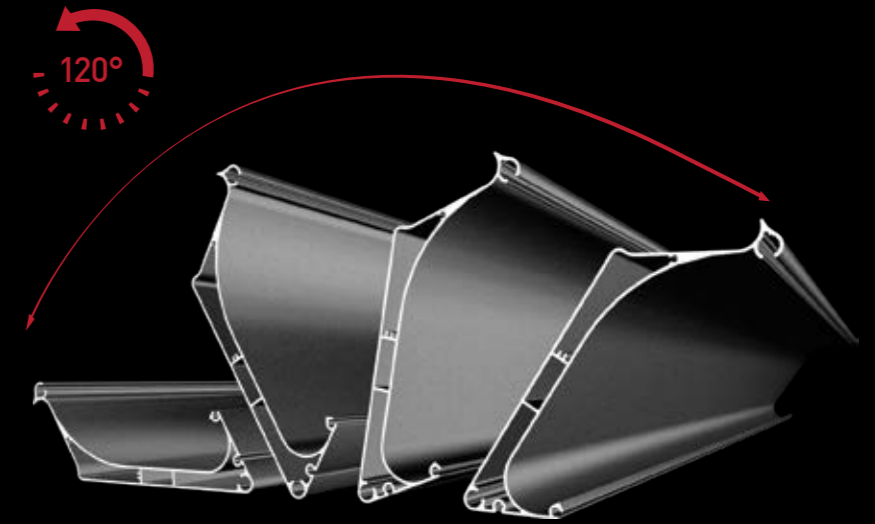

End-Point-Centered Rotation

This special rotating technology with its distinguished features provides many advantages like integrity, stability and sealing by means of end-point-centered operating structure and high pressured power system.

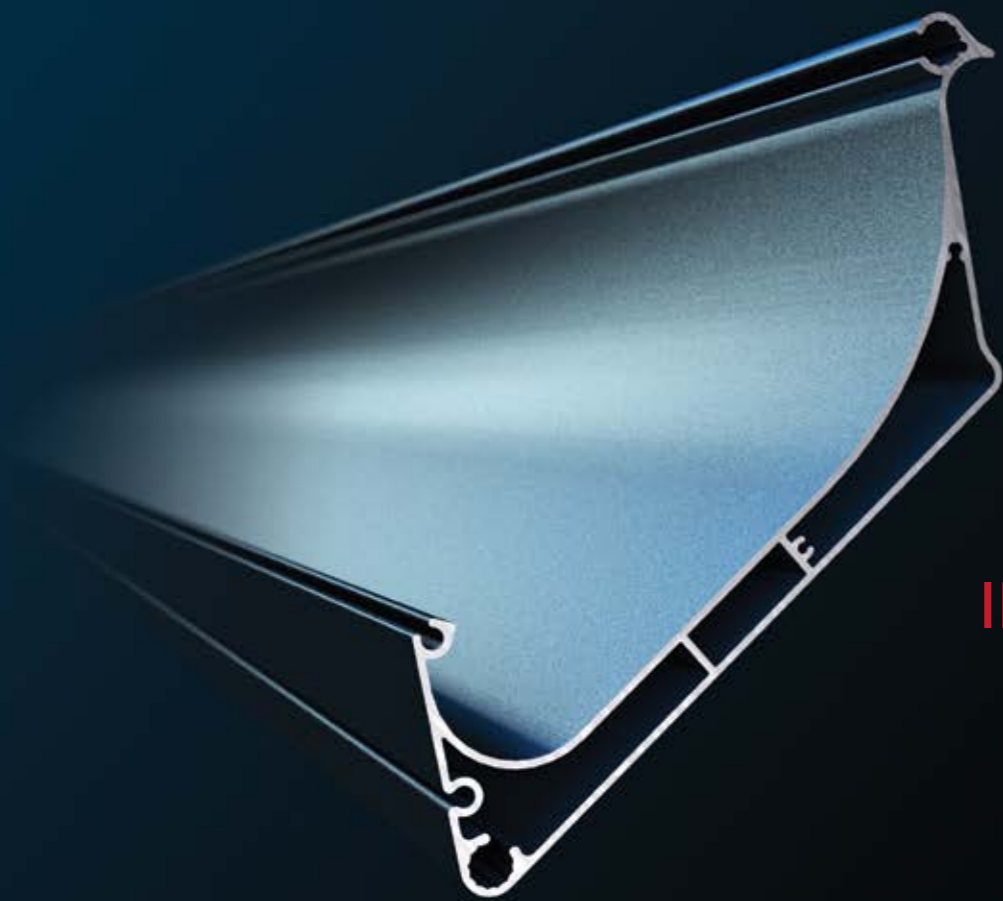

INTEGRATED PANEL GUTTER

Stay Clean

The elliptical chamber on top side of the panel prevents the accumulated materials falling into your indoor space during the panel rotation.

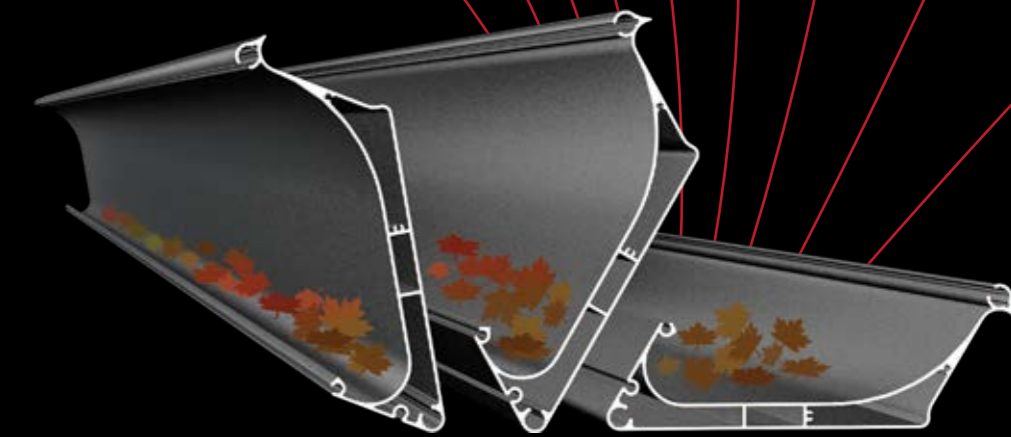



CLIMATE CONTROL

Insulated Panels

Panels can be filled with Polyurethane Foam which provides extra comfort. It significantly helps to reduce condensation.



Standard



Insulated



MULTI-SEALING SYSTEM

Powered by a linear actuator and sealed with high quality gasket plugs, providing a completely airtight space which can be used in all weather conditions.

Base Gasket

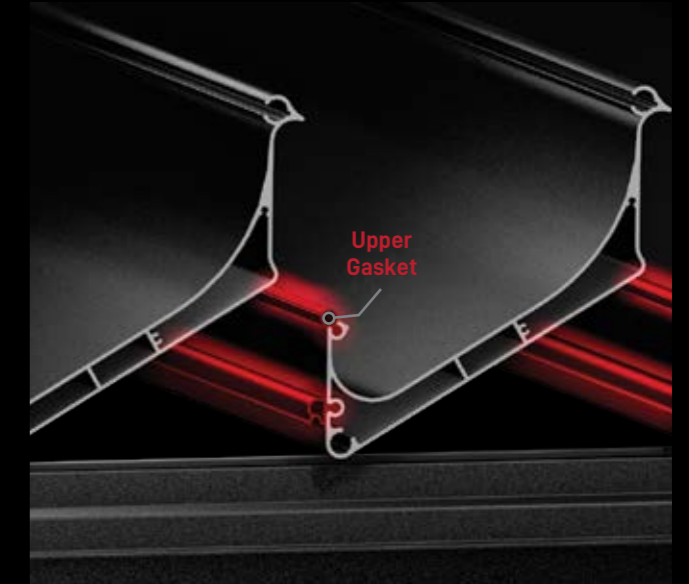
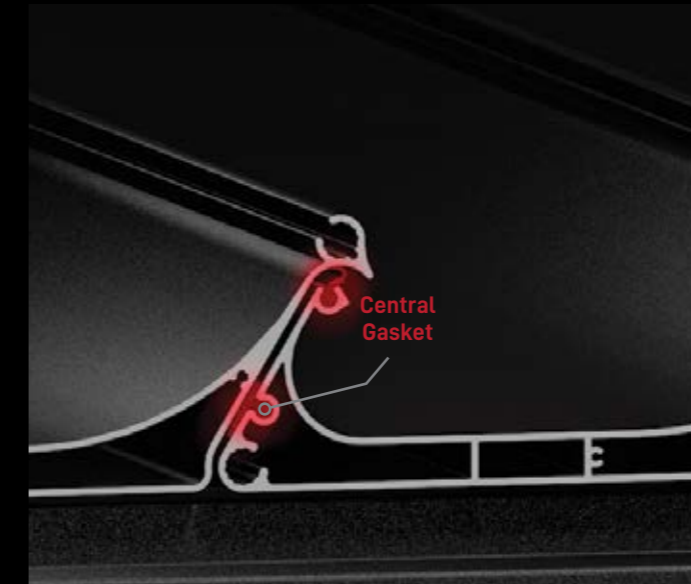

Air Tunnels

The panel structure provides heat and sound insulation and reduces condensation levels due to the thermal break.

HIGH PRESSURE CLOSING FUNCTION

Songs of power of the plane flaps
come alive with Skyroof. Linear
actuator system provides you to
isolate your spaces against severe
weather.







OPTIONS /
DETAILS



LIGHTING OPTIONS

Integrated lighting systems can be dimmed to create the perfect ambiance.

PERIMETER LIGHTING

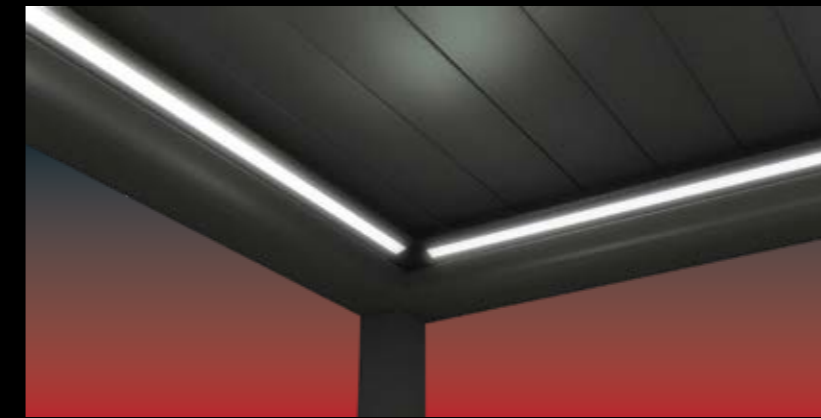

- > LED strips are integrated into the gutter profile.
- > Available on all series.

LINEAR LIGHTING

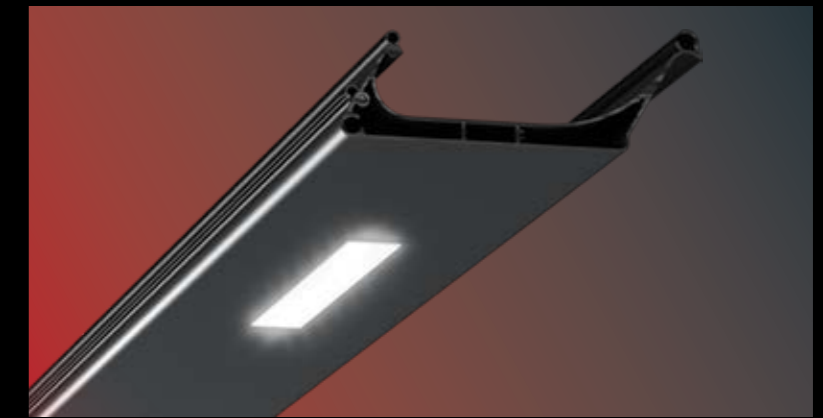

- > LED lightings are modules are positioned into the blades.
- > Plus series only.

CONTROL & AUTOMATION



CONNEXOON

Designed to easily control your product wherever you are in the world, despite the weather changes you can remotely activate your products accordingly.

Compatible with iOS and Android smartphone systems. You can assign multiple functions through created scenarios, you can give a one-touch command.



A *



B



C



D



E



A Telis 1 - Pure Elegant design that allows you to easily control your product.

* The standard control unity.

B Telis 1 - Lounge Elegant design with black color.

C Telis 1 - Patio IP 66 water-proof feature for outdoor use.

D 16-channel ergonomic design that allows you to control all functions at the same time from one control. By digital screen feature you can control different products with a symbol and a number given for different products.

E Functional design that allows the adjustment of the illuminations to the desired level with the Roller feature.



MULTI CHANNEL OPTIONS

Telis 1 is remote control with 1 channel, while the Telis 4 has got 5 channels. Telis 4 option is available for Pure, Lounge, Patio, RTS Lounge Roller and RTS Pure Roller.

SIDE COVER OPTIONS

For environmental protection or to create outdoor living areas used throughout four seasons, Skyroof sides can be covered by glass, vertical blinds, and aluminium panels.



Blinds and Awnings



Louvers



Glass Systems



COLOUR / OPTIONS

Choose your colour or colour combinations (dual colour). We coat our profiles with electrostatic powder paint using advanced Nanotechnology.

Colour Combinations

Panels can be painted with different colours than the main structure.

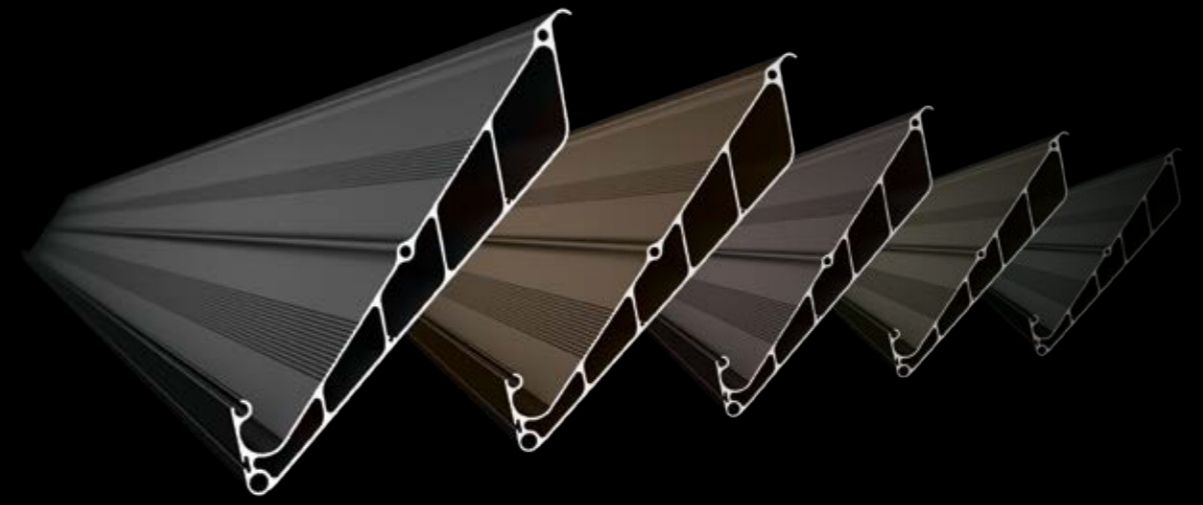

P R E S T I G E

P L U S & C O M P A C T



INTEGRATED BEAM & DRAINAGE SYSTEM

The integrated beam is the main carcass of the whole Skyroof system. All loads are shared equally to its structure. It also features as integrated gutter for drainage system.



Distribution Pieces

The distribution pieces route and accelerate the water through the pillars.

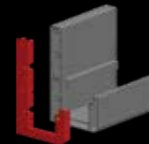

Water Blocking Barrier

The barrier blocks water to run inside the air tunnels.

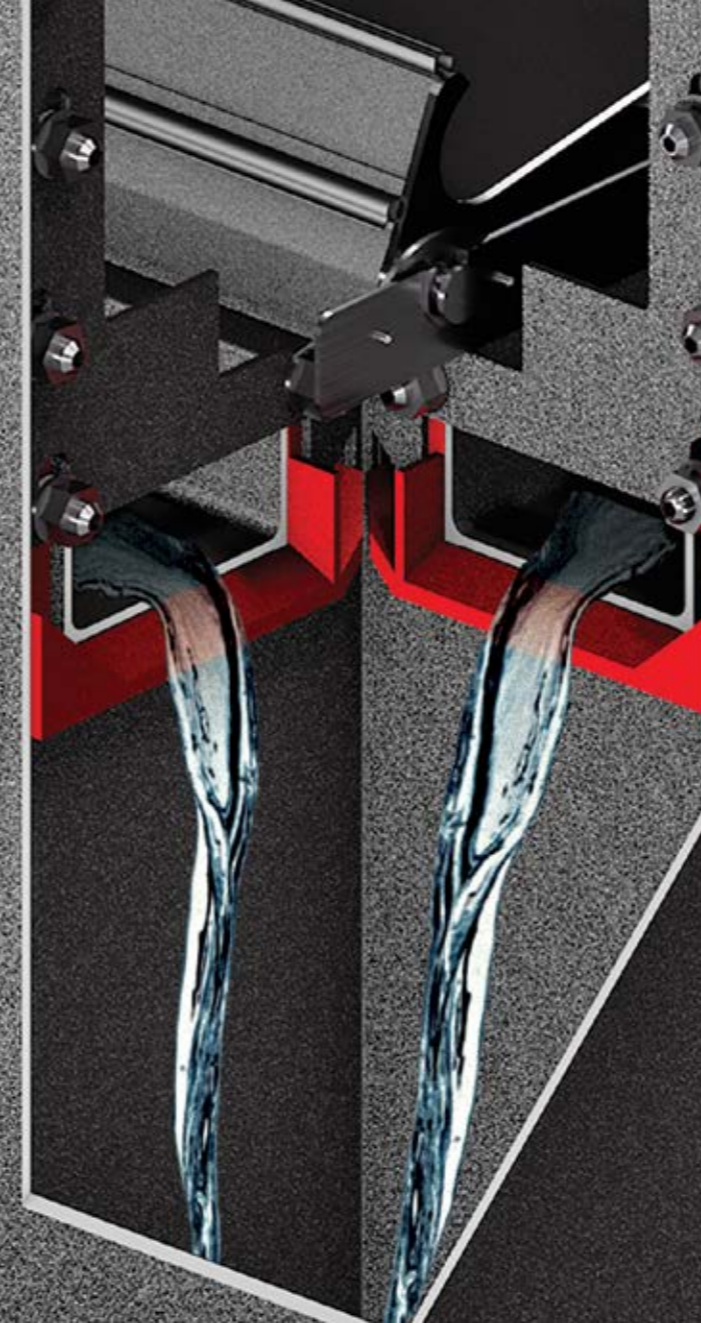

Integrated Drainage System

The hidden section of the drainage system is ingeniously integrated.



Specially designed aluminum panels guide the water through integrated gutters on all sides.



Water evacuates from the pillar.

MODULARITY

SKYROOF offers a wide variety of modular construction possibilities by means of its flexible and compact structural design.

2 MODULES

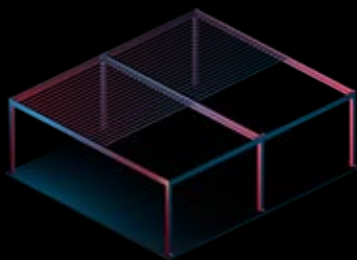

4 MODULES

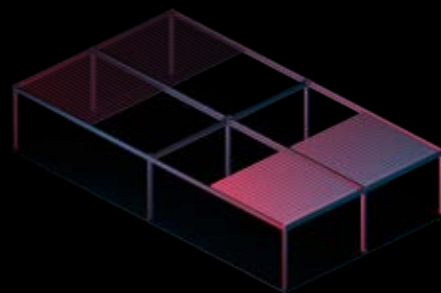

2-Module-Connector

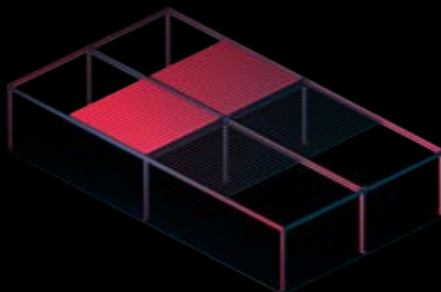

4-Module-Connector



APPLICATION TYPES

FREESTANDING

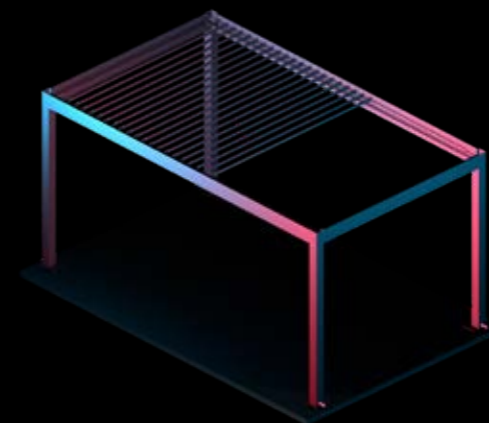

WALL MOUNTED

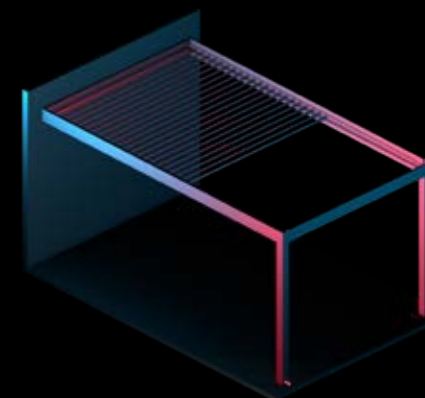































**5-YEAR
WARRANTY**

All our products have up
to 5 years guarantee for the
construction and motor.
The electronics and
remote controls are
guaranteed for



www.palmiye.eu

PALMIYE
Four Seasons Outdoor Living Areas